

Mathematics Curriculum: Grade Seven



The following maps outline the Common Core Standards for grade seven mathematics determined by the State Standards Initiative. Below is a list of assessment tools that are recommended for tracking student progress in these areas. In addition, resources that can be used in conjunction with instruction of these standards are provided but not limited to the list below.

Assessment:

Formative Assessment	Class-Work Review
Open-Ended Problems	Project-Based Assessment
Self-Assessment	Teacher Observation
End of Year Assessment	Group & Cooperative Work
Benchmark Assessment	Math Software (ex. Study Island)
Homework Review	
Summative Assessment	

Resources:

Math Journals	Center Games	Tangrams
Bar Models	Ten Frame	Geometric Shapes
Math Word Wall	Protractors	Geo-Board
Connecting Cubes	Mini White Boards	Textbooks
Number Line	Manipulatives	Rulers
Grid Paper	Math Songs/Poems	Three Dimensional Shapes
Computer Software	Calculators	Wiki-Sticks
Interactive White Board	Fraction Tiles	Pattern Blocks
Compass	Measurement Tools	

Websites:

http://www.aplusmath.com	www.wolframalpha.com	www.interactmath.com
http://www.studyisland.com	www.kutasoftware.com	www.number2.com
http://www.funbrain.com	www.illuminations.nctm.org	www.khanacademy.org
http://www.songsforteaching.com		www.betterlesson.com
www.purplemath.com		

References: <http://www.corestandards.org>
<http://www.ade.az.gov/standards/math/2010MathStandards>

**Math Curriculum
Grade Seven**

Essential Question(s): How can we use proportional relationships to solve real world problems?			
21st Century Theme: Financial, Economic, Business, and Entrepreneurial Literacy			
21st Century Skills: Critical Thinking and Problem Solving			
Content: Ratios & Proportional Relationships			
Standards: 7.RP.A.1			
A. Analyze proportional relationships and use them to solve real-world and mathematical problems.			
Vocabulary: rate, proportion, equivalent, coordinate plane, unit rate, slope			
Skills	Instructional Procedures	Explanations and Examples	Interdisciplinary Connections
<p>1. Compute unit rates associated with ratios of fractions, including ratios of lengths, areas and other quantities measured in like or different units. <i>For example, if a person walks 1/2 mile in each 1/4 hour, compute the unit rate as the complex fraction $\frac{1/2}{1/4}$ miles per hour, equivalently 2 miles per hour.</i></p>	<ul style="list-style-type: none"> • Introduce rate as a fraction • Review properties of proportions 	<p>If a car goes 60 miles in one hour, how far does it go in three hours?</p> $\frac{1 \text{ hr}}{60 \text{ mi}} = \frac{3 \text{ hours}}{x \text{ mile}}$	<p>Scaled Drawings Maps Dilations Cooking Science</p>
<p>2. Recognize and represent proportional relationships between quantities.</p> <p>CCSS.Math.Content.7.RP.A.2a Decide whether two quantities are in a proportional relationship, e.g., by testing for equivalent ratios in a table or graphing on a coordinate plane and observing whether the graph is a straight line through the</p>	<ul style="list-style-type: none"> • Demonstrate proportional relationships between quantities (ex. using cross multiplication) • Demonstrate relationship between slope and proportion • Demonstrate how to interpret a graph 	<p>Students may use a content web site and/or interactive white board to create tables and graphs of proportional or non-proportional relationships. Graphing proportional relationships represented in a table helps students recognize that the graph is a line through the origin (0,0) with a constant of proportionality equal to the slope of the line.</p> <p>Examples:</p> <ul style="list-style-type: none"> • A student is making trail mix. Create a graph to determine if the quantities of nuts and fruit are proportional for each serving size listed in the table. If the quantities are proportional, what is the constant of proportionality or unit rate that defines the relationship? Explain how you determined the constant of proportionality and how it relates to both the table and graph. 	<p>Scaled Drawings Maps Dilations Cooking Science</p>

origin.

[CCSS.Math.Content.7.RP.A.2b](#)

Identify the constant of proportionality (unit rate) in tables, graphs, equations, diagrams, and verbal descriptions of proportional relationships.

[CCSS.Math.Content.7.RP.A.2c](#)

Represent proportional relationships by equations.

For example, if total cost t is proportional to the number n of items purchased at a constant price p , the relationship between the total cost and the number of items can be expressed as $t = pn$.

[CCSS.Math.Content.7.RP.A.2d](#)

Explain what a point (x, y) on the graph of a proportional relationship means in terms of the situation, with special attention to the points $(0, 0)$ and $(1, r)$ where r is the unit rate.

Serving Size	1	2	3	4
Cups of Nuts (x)	1	2	3	4
Cups of Fruit (y)	2	4	6	8

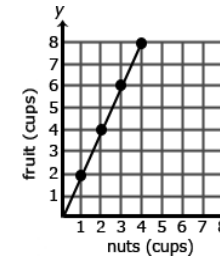

The relationship is proportional. For each of the other serving sizes there are 2 cups of fruit for every 1 cup of nuts (2:1).

The constant of proportionality is shown in the first column of the table and by the slope of the line on the graph.

- The graph below represents the cost of gum packs as a unit rate of \$2 dollars for every pack of gum. The unit rate is represented as \$2/pack. Represent the relationship using a table and an equation.

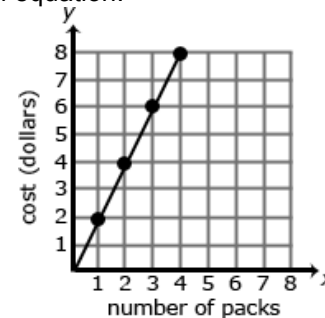

Table:

Number of Packs of Gum (g)	Cost in Dollars (d)
0	0
1	2
2	4
3	6
4	8

Equation: $2g = d$, where d is the cost in dollars and g is the packs of gum

A common error is to reverse the position of the variables when writing equations. Students may find it useful to use variables specifically related to the quantities rather than using x and y . Constructing verbal models can also be helpful. A student might describe the situation as “the number of packs of gum times the cost for each pack is the total cost in dollars.” They can use this verbal

		<p>model to construct the equation. Students can check their equation by substituting values and comparing their results to the table. The checking process helps student revise and recheck their model as necessary. The number of packs of gum times the cost for each pack is the total cost ($g \times 2 = d$).</p>											
<p>3. Use proportional relationships to solve multistep ratio and percent problems. Examples: simple interest, tax, markups and markdowns, gratuities and commissions, fees, percent increase and decrease, percent error</p>	<ul style="list-style-type: none"> Review vocabulary (simple interest, tax, markups and markdowns, gratuities and commissions, fees, percent increase and decrease, percent error) 	<p>Students should be able to explain or show their work using a representation (numbers, words, pictures, physical objects, or equations) and verify that their answer is reasonable. Models help students to identify the parts of the problem and how the values are related. For percent increase and decrease, students identify the starting value, determine the difference, and compare the difference in the two values to the starting value.</p> <p>Examples:</p> <ul style="list-style-type: none"> Gas prices are projected to increase 124% by April 2015. A gallon of gas currently costs \$4.17. What is the projected cost of a gallon of gas for April 2015? <p>A student might say: "The original cost of a gallon of gas is \$4.17. An increase of 100% means that the cost will double. I will also need to add another 24% to figure out the final projected cost of a gallon of gas. Since 25% of \$4.17 is about \$1.04, the projected cost of a gallon of gas should be around \$9.40."</p> $\$4.17 + 4.17 + (0.24 \bullet 4.17) = 2.24 \times 4.17$ <table border="1" data-bbox="1003 847 1656 966"> <tr> <td>100%</td> <td>+100%</td> <td>+24%</td> </tr> <tr> <td>\$4.17</td> <td>\$4.17</td> <td>?</td> </tr> </table> <ul style="list-style-type: none"> A sweater is marked down 33%. Its original price was \$37.50. What is the price of the sweater before sales tax? <table border="1" data-bbox="987 1070 1671 1235"> <tr> <td colspan="2" style="text-align: center;">37.50 Original Price of Sweater</td> </tr> <tr> <td style="text-align: center;">33% of 37.50 Discount</td> <td style="text-align: center;">67% of 37.50 Sale price of sweater</td> </tr> </table> <p>The discount is 33% times 37.50. The sale price of the sweater is the original price minus the discount or 67% of the original price of the sweater, or Sale Price = 0.67 x Original Price.</p>	100%	+100%	+24%	\$4.17	\$4.17	?	37.50 Original Price of Sweater		33% of 37.50 Discount	67% of 37.50 Sale price of sweater	<p>Consumer shopping Taxes Business Science</p>
100%	+100%	+24%											
\$4.17	\$4.17	?											
37.50 Original Price of Sweater													
33% of 37.50 Discount	67% of 37.50 Sale price of sweater												

Discount
40% of original price

Sale Price is \$12
60% of original price

$$0.60p = 12$$

Original Price (p)

- A shirt is on sale for 40% off. The sale price is \$12. What was the original price? What was the amount of the discount?

- At a certain store, 48 television sets were sold in April. The manager at the store wants to encourage the sales team to sell more TVs and is going to give all the sales team members a bonus if the number of TVs sold increases by 30% in May. How many TVs must the sales team sell in May to receive the bonus? Justify your solution.
- A salesperson set a goal to earn \$2,000 in May. He receives a base salary of \$500 as well as a 10% commission for all sales. How much merchandise will he have to sell to meet his goal?
- After eating at a restaurant, your bill before tax is \$52.60. The sales tax rate is 8%. You decide to leave a 20% tip for the waiter based on the pre-tax amount. How much is the tip you leave for the waiter? How much will the total bill be, including tax and tip? Express your solution as a multiple of the bill.
The amount paid = $0.20 \times \$52.50 + 0.08 \times \$52.50 = 0.28 \times \$52.50$

**Math Curriculum
Grade Seven**

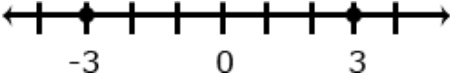
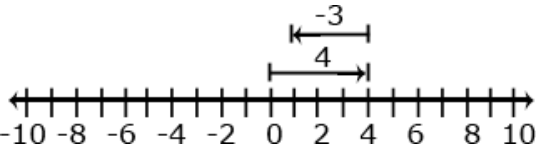
Essential Question(s): How do you apply integer rules to operations involving rational numbers?			
21st Century Theme: Financial, Economic, Business, and Entrepreneurial Literacy			
21st Century Skills: Critical Thinking and Problem Solving			
Content: The Number System			
Standards: 7.NS.A			
A. Apply and extend previous understandings of operations with fractions.			
Vocabulary: additive inverse (opposite), absolute value, operations, terminating decimals, repeating decimal			
Skills	Instructional Procedures	Explanations and Examples	Interdisciplinary Connections
<p>1. Apply and extend previous understandings of addition and subtraction to add and subtract rational numbers; represent addition and subtraction on a horizontal or vertical number line diagram.</p> <p>CCSS.Math.Content.7.NS.A.1a Describe situations in which opposite quantities combine to make 0. <i>For example, a hydrogen atom has 0 charge because its two constituents are oppositely charged.</i></p> <p>CCSS.Math.Content.7.NS.A.1b Understand $p + q$ as the number located a distance q from p, in the positive or negative direction depending on whether q is positive or negative. Show that a number and its opposite have a sum of 0 (are additive inverses). Interpret sums of rational numbers by describing real-world contexts.</p>	<ul style="list-style-type: none"> • Demonstrate how to construct a number line • Demonstrate integer operations using a number line • Demonstrate absolute value on a number line • Demonstrate an additive inverse on a number line 	<p>Visual representations may be helpful as students begin this work; they become less necessary as students become more fluent with the operations.</p> <p>Examples:</p> <ul style="list-style-type: none"> • Use a number line to illustrate: <ul style="list-style-type: none"> ○ $p - q$ ○ $p + (-q)$ ○ Is this equation true $p - q = p + (-q)$ • -3 and 3 are shown to be opposites on the number line because they are equal distance from zero and therefore have the same absolute value and the sum of the number and its opposite is zero.  <ul style="list-style-type: none"> • You have \$4 and you need to pay a friend \$3. What will you have after paying your friend? $4 + (-3) = 1$ or $(-3) + 4 = 1$ 	<p>Science Real world applications Business applications</p>

[CCSS.Math.Content.7.NS.A.1c](#)

Understand subtraction of rational numbers as adding the additive inverse, $p - q = p + (-q)$. Show that the distance between two rational numbers on the number line is the absolute value of their difference, and apply this principle in real-world contexts.

[CCSS.Math.Content.7.NS.A.1d](#)

Apply properties of operations as strategies to add and subtract rational numbers

2. Apply and extend previous understandings of multiplication and division and of fractions to multiply and divide rational numbers.

[CCSS.Math.Content.7.NS.A.2a](#)

Understand that multiplication is extended from fractions to rational numbers by requiring that operations continue to satisfy the properties of operations, particularly the distributive property, leading to products such as $(-1)(-1) = 1$ and the rules for multiplying signed numbers. Interpret products of rational numbers by describing real-world contexts.

[CCSS.Math.Content.7.NS.A.2b](#)

Understand that integers can be divided, provided that the divisor is not zero, and every quotient of integers (with non-

- Review operations with fractions
- Apply integer rules with fractional operations
- Apply operations using integers
- Apply distributive property to integer operations

Multiplication and division of integers is an extension of multiplication and division of whole numbers.

Examples:

- Examine the family of equations. What patterns do you see? Create a model and context for each of the products.

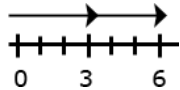
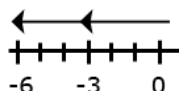
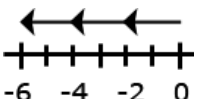
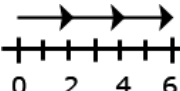
Equation	Number Line Model	Context
$2 \times 3 = 6$		Selling two posters at \$3.00 per poster
$2 \times -3 = -6$		Spending 3 dollars each on 2 posters
$-2 \times 3 = -6$		Owing 2 dollars to each of your three friends
$-2 \times -3 = 6$		Forgiving 3 debts of \$2.00 each

Science
Real world applications
Business applications
Banking
Construction
Architecture

<p>zero divisor) is a rational number. If p and q are integers, then $-(p/q) = (-p)/q = p/(-q)$. Interpret quotients of rational numbers by describing real-world contexts.</p> <p>CCSS.Math.Content.7.NS.A.2c Apply properties of operations as strategies to multiply and divide rational numbers.</p> <p>CCSS.Math.Content.7.NS.A.2d Convert a rational number to a decimal using long division; know that the decimal form of a rational number terminates in 0s or eventually repeats.</p>			
<p>3. Solve real-world and mathematical problems involving the four operations with rational numbers.¹</p>	<ul style="list-style-type: none"> • Provide open-ended questions and model solutions and strategies 	<p>Examples:</p> <ul style="list-style-type: none"> • Your cell phone bill is automatically deducting \$32 from your bank account every month. How much will the deductions total for the year? $-32 + -32 + -32 + -32 + -32 + -32 + -32 + -32 + -32 + -32 + -32 + -32 = 12 (-32)$ <ul style="list-style-type: none"> • It took a submarine 20 seconds to drop to 100 feet below sea level from the surface. What was the rate of the descent? $\frac{-100 \text{ feet}}{20 \text{ seconds}} = \frac{-5 \text{ feet}}{1 \text{ second}} = -5 \text{ ft/sec}$	

¹ Computations with rational numbers extend the rules for manipulating fractions to complex fractions.

**Math Curriculum
Grade Seven**

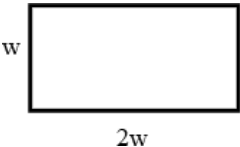
Essential Question(s): How can order of operations be used to simplify expressions?			
How can algebra be used to write expressions in equivalent forms?			
21st Century Theme: Financial, Economic, Business, and Entrepreneurial Literacy			
21st Century Skills: Critical Thinking and Problem Solving			
Content: Expressions and Equations			
Standards: 7.EE.A			
A. Use properties of operations to generate equivalent expressions.			
Vocabulary: expression, equivalent, solution, simplify, evaluate, order of operations, factor, rational, equation, combine like terms, coefficient, variables, constant			
Skills	Instructional Procedures	Explanations and Examples	Interdisciplinary Connections
1. Apply properties of operations as strategies to add, subtract, factor, and expand linear expressions with rational coefficients.	<ul style="list-style-type: none"> • Review order of operations • Review distributive property • Review combining like terms • Review perimeter • Review GCF/LCM 	<p>Examples:</p> <ul style="list-style-type: none"> • Write an equivalent expression for $3(x + 5) - 2$. • Suzanne thinks the two expressions $2(3a - 2) + 4a$ and $10a - 2$ are equivalent. Is she correct? Explain why or why not? • Write equivalent expressions for: $3a + 12$ <p>Possible solutions might include factoring as in $3(a + 4)$, or other expressions such as $a + 2a + 7 + 5$.</p> <ul style="list-style-type: none"> • A rectangle is twice as long as wide. One way to write an expression to find the perimeter would be $w + w + 2w + 2w$. Write the expression in two other ways. <p>Solution: $6w$ OR $2(w) + 2(2w)$.</p> <div style="text-align: center;">  </div>	Science Real word applications Social studies

		<ul style="list-style-type: none"> An equilateral triangle has a perimeter of $6x + 15$. What is the length of each of the sides of the triangle? <p>Solution: $3(2x + 5)$, therefore each side is $2x + 5$ units long.</p>	
<p>2. Understand that rewriting an expression in different forms in a problem context can shed light on the problem and how the quantities in it are related. <i>For example, $a + 0.05a = 1.05a$ means that "increase by 5%" is the same as "multiply by 1.05."</i></p>	<ul style="list-style-type: none"> Relate percents to decimals Demonstrate how algebra can be used to write expressions in equivalent forms Demonstrate ability to communicate math in written form 	<p>Examples:</p> <ul style="list-style-type: none"> Jamie and Ted both get paid an equal hourly wage of \$9 per hour. This week, Ted made an additional \$27 dollars in overtime. Write an expression that represents the weekly wages of both if J = the number of hours that Jamie worked this week and T = the number of hours Ted worked this week? Can you write the expression in another way? <p>Students may create several different expressions depending upon how they group the quantities in the problem.</p> <p>One student might say: To find the total wage, I would first multiply the number of hours Jamie worked by 9. Then I would multiply the number of hours Ted worked by 9. I would add these two values with the \$27 overtime to find the total wages for the week. The student would write the expression $9J + 9T + 27$.</p> <p>Another student might say: To find the total wages, I would add the number of hours that Ted and Jamie worked. I would multiply the total number of hours worked by 9. I would then add the overtime to that value to get the total wages for the week. The student would write the expression $9(J + T) + 27$</p> <p>A third student might say: To find the total wages, I would need to figure out how much Jamie made and add that to how much Ted made for the week. To figure out Jamie's wages, I would multiply the number of hours she worked by 9. To figure out Ted's wages, I would multiply the number of hours he worked by 9 and then add the \$27 he earned in overtime. My final step would be to add Jamie and Ted wages for the week to find their combined total wages. The student would write the expression $(9J) + (9T + 27)$</p>	<p><u>Real world applications</u> <u>Language Arts:</u> Synonyms <u>Science:</u> Equivalent results regardless of procedure</p>

- Given a square pool as shown in the picture, write four different expressions to find the total number of tiles in the border. Explain how each of the expressions relates to the diagram and demonstrate that the expressions are equivalent. Which expression do you think is most useful? Explain your thinking.

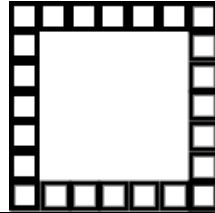

**Math Curriculum
Grade Seven**

Essential Question(s): How can real world mathematical problems be solved using both mental and computational strategies?			
21st Century Theme: Financial, Economic, Business, and Entrepreneurial Literacy			
21st Century Skills: Critical Thinking and Problem Solving			
Content: Expressions and Equations			
Standards: 7.EE.			
B. Solve real-life and mathematical problems using numerical and algebraic expressions and equations.			
Vocabulary: estimations, integers, clustering, consecutive, inequality, interpret			
Skills	Instructional Procedures	Explanations and Examples	Interdisciplinary Connections
<p>3. Solve multi-step real-life and mathematical problems posed with positive and negative rational numbers in any form (whole numbers, fractions, and decimals), using tools strategically. Apply properties of operations to calculate with numbers in any form; convert between forms as appropriate; and assess the reasonableness of answers using mental computation and estimation strategies. <i>For example: If a woman making \$25 an hour gets a 10% raise, she will make an additional $\frac{1}{10}$ of her salary an hour, or \$2.50, for a new salary of \$27.50. If you want to place a towel bar $9\frac{3}{4}$ inches long in the center of a door that is $27\frac{1}{2}$ inches wide, you will need to place</i></p>	<ul style="list-style-type: none"> • Review decimal, fraction, percent conversions • Review estimation strategies • Use numerical and algebraic expression to represent real world problems • Use numerical and algebraic equations to solve real world problems 	<p>Estimation strategies for calculations with fractions and decimals extend from students' work with whole number operations. Estimation strategies include, but are not limited to:</p> <ul style="list-style-type: none"> • front-end estimation with adjusting (using the highest place value and estimating from the front end making adjustments to the estimate by taking into account the remaining amounts), • clustering around an average (when the values are close together an average value is selected and multiplied by the number of values to determine an estimate), • rounding and adjusting (students round down or round up and then adjust their estimate depending on how much the rounding affected the original values), • using friendly or compatible numbers such as factors (students seek to fit numbers together - i.e., rounding to factors and grouping numbers together that have round sums like 100 or 1000), and • using benchmark numbers that are easy to compute (students select close whole numbers for fractions or decimals to determine an estimate). 	<p><u>Social Studies:</u> Population <u>Science</u></p>

the bar about 9 inches from each edge; this estimate can be used as a check on the exact computation.

Example:

- The youth group is going on a trip to the state fair. The trip costs \$52. Included in that price is \$11 for a concert ticket and the cost of 2 passes, one for the rides and one for the game booths. Each of the passes cost the same price. Write an equation representing the cost of the trip and determine the price of one pass.

$$2x + 11 = 52$$

$$2x = 41$$

$$x = \$20.50$$

4. Use variables to represent quantities in a real-world or mathematical problem, and construct simple equations and inequalities to solve problems by reasoning about the quantities.

- Review solving inequalities, including the use of graphing
- Review solving one- and two-step equations and inequalities

Examples:

- Amie had \$26 dollars to spend on school supplies. After buying 10 pens, she had \$14.30 left. How much did each pen cost?
- The sum of three consecutive even numbers is 48. What is the smallest of these numbers?
- Solve: $\frac{5}{4}n + 5 = 20$
- Florencia has at most \$60 to spend on clothes. She wants to buy a pair of jeans for \$22 dollars and spend the rest on t-shirts. Each t-shirt costs \$8. Write an inequality for the number of t-shirts she can purchase.
- Steven has \$25 dollars. He spent \$10.81, including tax, to buy a new DVD. He needs to set aside \$10.00 to pay for his lunch next week. If peanuts cost \$0.38 per package including tax, what is the maximum number of packages that Steven can buy?

Write an equation or inequality to model the situation. Explain how you determined whether to write an equation or inequality and the properties of the real number system that you used to find a solution.

Solve $\frac{1}{2}x + 3 > 2$ and graph your solution on a number line.

[CCSS.Math.Content.7.EE.B.](#)

4a Solve word problems leading to equations of the form $px + q = r$ and $p(x + q) = r$, where p , q , and r are specific rational numbers. Solve equations of these forms fluently. Compare an algebraic solution to an arithmetic solution, identifying the sequence of the operations used in each approach. *For example, the perimeter of a rectangle is 54 cm. Its length is 6 cm. What is its width?*

[CCSS.Math.Content.7.EE.B.](#)

4b Solve word problems leading to inequalities of the

form $px + q > r$ or $px + q < r$, where p , q , and r are specific rational numbers. Graph the solution set of the inequality and interpret it in the context of the problem. *For example: As a salesperson, you are paid \$50 per week plus \$3 per sale. This week you want your pay to be at least \$100. Write an inequality for the number of sales you need to make, and describe the solutions.*

**Math Curriculum
Grade Seven**

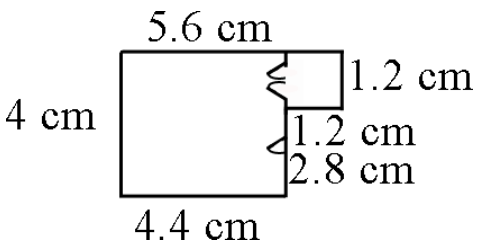
Essential Question(s): How does geometry allow us to reason proportionally and reorganize relationships between figures?			
21st Century Theme: Financial, Economic, Business, and Entrepreneurial Literacy			
21st Century Skills: Critical Thinking and Problem Solving			
Content: Geometry			
Standards: 7. G			
A. Draw, construct, and describe geometrical figures and describe the relationships between them.			
Vocabulary: ratio, proportions, scale, factor, corresponding sides, corresponding angles, similar figures, cross section, right rectangular prism, right rectangle pyramid			
Skills	Instructional Procedures	Explanations and Examples	Interdisciplinary Connections
1. Solve problems involving scale drawings of geometric figures, including computing actual lengths and areas from a scale drawing and reproducing a scale drawing at a different scale.	<ul style="list-style-type: none"> Review ratio, proportion and percent Identify corresponding parts of geometric figures Calculate scale factor Enlarge and shrink two-dimensional figures Analyze scale factors between figures and conclude that between 0 and 1 reduces and greater than 1 enlarges 	<p>Example:</p> <ul style="list-style-type: none"> Julie showed you the scale drawing of her room. If each 2 cm on the scale drawing equals 5 ft, what are the actual dimensions of Julie's room? Reproduce the drawing at 3 times its current size. 	Art Maps Architectural drawings Photography Technology Mazes Carpentry
2. Draw (freehand, with ruler and protractor, and with technology) geometric shapes with given conditions. Focus on constructing triangles from three measures of angles or sides, noticing when the conditions determine a unique triangle, more than one	<ul style="list-style-type: none"> Sketch and label geometric shapes with given conditions Apply basic rules of constructions Construct a triangle with given measurements Given conditions, determine whether you can construct a unique triangle, more than one 	<p>Conditions may involve points, line segments, angles, parallelism, congruence, angles, and perpendicularity.</p> <p>Examples:</p> <ul style="list-style-type: none"> Is it possible to draw a triangle with a 90° angle and one leg that is 4 inches long and one leg that is 3 inches long? If so, draw one. Is there more than one such triangle? Draw a triangle with angles that are 60 degrees. Is this a unique triangle? Why or why not? Draw an isosceles triangle with only one 80 degree angle. Is this 	<u>Technology:</u> Geometer's Sketchpad <u>Carpentry</u> <u>Architecture</u>

<p>triangle, or no triangle.</p>	<p>triangle or no triangle. Explain</p>	<p>the only possibility or can you draw another triangle that will also meet these conditions?</p> <ul style="list-style-type: none"> • Can you draw a triangle with sides that are 13 cm, 5 cm and 6 cm? • Draw a quadrilateral with one set of parallel sides and no right angles. 	
<p>3. Describe the two-dimensional figures that result from slicing three-dimensional figures, as in plane sections of right rectangular prisms and right rectangular pyramids.</p>	<ul style="list-style-type: none"> • Recognize 3-dimensional figures • Model a plane slicing a 3-dimensional figure • Identify cross sections of 3-dimensional figures 	<p>Example:</p> <ul style="list-style-type: none"> • Using a model of a rectangular prism, describe the shapes that are created when slicing the prism. 	<p>Donald Duck in Math Magic Land Diagnostic Procedures Forensic Science</p>

**Math Curriculum
Grade Seven**

Essential Question(s): How can we use strategies for finding area and volume to solve real-life problems?			
21st Century Theme: Financial, Economic, Business, and Entrepreneurial Literacy			
21st Century Skills: Critical Thinking and Problem Solving			
Content: Geometry			
Standards: 7.G			
B. Solve real-life and mathematical problems involving angle measure, area, surface area, and volume.			
Vocabulary: area, circumference, π , supplementary, complementary, vertical adjacent, surface area, nets, volume			
Skills	Instructional Procedures	Explanations and Examples	Interdisciplinary Connections
4. Know the formulas for the area and circumference of a circle and use them to solve problems; give an informal derivation of the relationship between the circumference and area of a circle.	<ul style="list-style-type: none"> Review concepts of area and perimeter of polygons and relate them to area and circumference of circles Calculate the value of π using $\frac{C}{d}$ Apply the formula to solve word problems 	<p>Examples:</p> <ul style="list-style-type: none"> The seventh grade class is building a mini golf game for the school carnival. The end of the putting green will be a circle. If the circle is 10 feet in diameter, how many square feet of grass carpet will they need to buy to cover the circle? How might you communicate this information to the salesperson to make sure you receive a piece of carpet that is the correct size? Students measure the circumference and diameter of several circular objects in the room (clock, trash can, door knob, wheel, etc.). Students organize their information and discover the relationship between circumference and diameter by noticing the pattern in the ratio of the measures. Students write an expression that could be used to find the circumference of a circle with any diameter and check their expression on other circles. Compare the ratio of $\frac{C}{d}$ 	Baking- Cake Boss Fashion

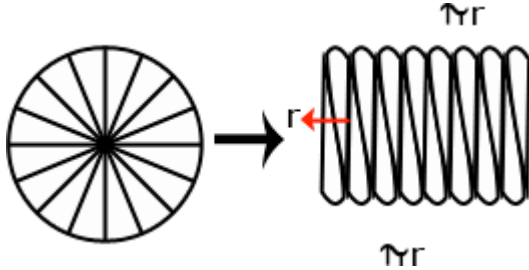
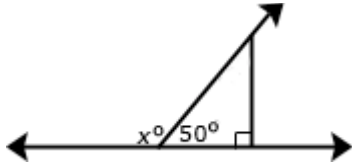
		<ul style="list-style-type: none"> Students will use a circle as a model to make several equal parts as you would in a pie model. The greater number of parts, the more accurate the representation will be. The pie pieces are laid out to form a shape similar to a parallelogram. Students will then write an expression for the area of the parallelogram related to the radius (note: the length of the base of the parallelogram is half the circumference, or πr, and the height is r, resulting in an area of πr^2). Extension: If students are given the circumference of a circle, could they write a formula to determine the circle's area or given the area of a circle, could they write the formula for the circumference? 	
<p>5. Use facts about supplementary, complementary, vertical, and adjacent angles in a multi-step problem to write and solve simple equations for an unknown angle in a figure.</p>	<ul style="list-style-type: none"> Review the definition of supplementary, complementary, vertical and adjacent angles Use properties about supplementary, complementary, vertical and adjacent angles to write an equation to find an unknown angle measure 	<p>Angle relationships that can be explored include but are not limited to:</p> <ul style="list-style-type: none"> Same-side (consecutive) interior and same-side (consecutive) exterior angles are supplementary. <p>Examples:</p> <ul style="list-style-type: none"> Write and solve an equation to find the measure of angle x. 	

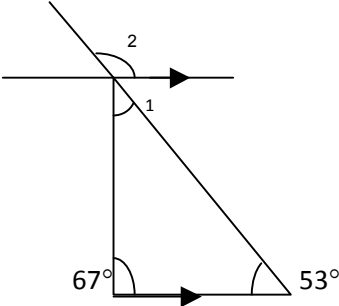
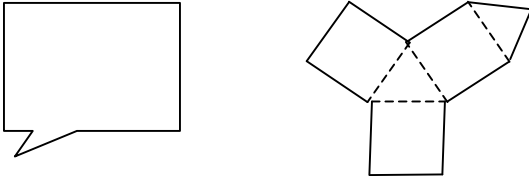
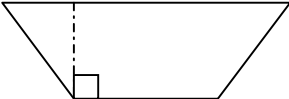
	<p>3</p> <p>7</p>	<ul style="list-style-type: none"> Find the measure of each numbered angle. 	
<p>6. Solve real-world and mathematical problems involving area, volume and surface area of two- and three-dimensional objects composed of triangles, quadrilaterals, polygons, cubes, and right prisms.</p>	<ul style="list-style-type: none"> Review the relationship between nets and their solids Use this relationship to calculate surface area Compare and contrast area, surface area and volume Use these relationships to solve real- world problems 	<p>Students' understanding of volume can be supported by focusing on the area of base times the height to calculate volume. Students' understanding of surface area can be supported by focusing on the sum of the area of the faces. Nets can be used to evaluate surface area calculations.</p> <p>Examples:</p> <ul style="list-style-type: none"> Choose one of the figures shown below and write a step-by-step procedure for determining the area. Find another person that chose the same figure as you did. How are your procedures the same and different? Do they yield the same result?  <ul style="list-style-type: none"> A cereal box is a rectangular prism. What is the volume of the cereal box? What is the surface area of the cereal box? (Hint: Create a net of the cereal box and use the net to calculate the surface area.) Make a poster explaining your work to share with the class. Find the area of a triangle with a base length of three units and a height of four units. Find the area of the trapezoid shown below using the formulas for rectangles and triangles. 	<p>Packaging Consumer education</p>

--	--	--	--

**Math Curriculum
Grade Seven**

Essential Question(s): How can outcomes be predicted based on a sample population?			
21st Century Theme: Financial, Economic, Business, and Entrepreneurial Literacy			
21st Century Skills: Critical Thinking and Problem Solving			
Content: 7.SP			
Standards: Statistics and Probability			
A. Use random sampling to draw inferences about a population.			
Vocabulary: population, sample, validity, inference, probability, prediction			
Skills	Instructional Procedures	Explanations and Examples	Interdisciplinary Connections
1. Understand that statistics can be used to gain information about a population by examining a sample of the population; generalizations about a population from a sample are valid only if	<ul style="list-style-type: none"> • Explain the relationship between sample and population • Explain different types of sampling 	<p>Example:</p> <ul style="list-style-type: none"> • The school food service wants to increase the number of students who eat hot lunch in the cafeteria. The student council has been asked to conduct a survey of the student body to determine the students' preferences for hot lunch. They have determined two ways to do the survey. The two methods are listed below. Identify the type of sampling used in each survey option. Which survey option should the student council use and why? <p>1. Write all of the students' names on cards and pull them out in a</p>	<p>Polling Data collection</p>

the sample is representative of that population. Understand that random sampling tends to produce representative samples and support valid inferences.

- draw to determine who will complete the survey.
 2. Survey the first 20 students that enter the lunch room.

2. Use data from a random sample to draw inferences about a population with an unknown characteristic of interest. Generate multiple samples (or simulated samples) of the same size to gauge the variation in estimates or predictions. *For example, estimate the mean word length in a book by randomly sampling words from the book; predict the winner of a school election based on randomly sampled survey data. Gauge how far off the estimate or prediction might be.*

- Analyze data

Example:
 • Below is the data collected from two random samples of 100 students regarding each student's school lunch preference. Make at least two inferences based on the results.

Lunch Preferences

student sample	hamburgers	tacos	pizza	total
#1	12	14	74	100
#2	12	11	77	100

Science

**Math Curriculum
Grade Seven**

Essential Question(s): How are statistics used to compare samples and populations?			
21st Century Theme: Financial, Economic, Business, and Entrepreneurial Literacy			
21st Century Skills: Critical Thinking and Problem Solving			
Content: 7.SP			
Standards: Statistics and Probability			
B. Draw informal comparative inferences about two populations.			
Vocabulary: deviation, distribution, variability			
Skills	Instructional Procedures	Explanations and Examples	Interdisciplinary Connections
<p>3. Informally assess the degree of visual overlap of two numerical data distributions with similar variabilities, measuring the difference between the centers by expressing it as a multiple of a measure of variability. <i>For example, the mean height of players on the basketball team is 10 cm greater than the mean height of players on the soccer team, about twice the variability (mean absolute deviation) on either team; on a dot plot, the separation between the two distributions of heights is noticeable.</i></p>	<ul style="list-style-type: none"> • Review different types of data analysis (ex. types of graphs) • Review measures of center • Demonstrate how statistical information is represented on a graph 	<p>Students can readily find data as described in the example on sports team or college websites. Other sources for data include American Fact Finder (Census Bureau), Fed Stats, Ecology Explorers, USGS, or CIA World Factbook. Researching data sets provides opportunities to connect mathematics to their interests and other academic subjects. Students can utilize statistic functions in graphing calculators or spreadsheets for calculations with larger data sets or to check their computations. Students calculate mean absolute deviations in preparation for later work with standard deviations.</p> <p>Example: Jason wanted to compare the mean height of the players on his favorite basketball and soccer teams. He thinks the mean height of the players on the basketball team will be greater but doesn't know how much greater. He also wonders if the variability of heights of the athletes is related to the sport they play. He thinks that there will be a greater variability in the heights of soccer players as compared to basketball players. He used the rosters and player statistics from the team websites to generate the following lists.</p> <p>Basketball Team – Height of Players in inches for 2010-2011 Season 75, 73, 76, 78, 79, 78, 79, 81, 80, 82, 81, 84, 82, 84, 80, 84</p> <p>Soccer Team – Height of Players in inches for 2010 73, 73, 73, 72, 69, 76, 72, 73, 74, 70, 65, 71, 74, 76, 70, 72, 71, 74, 71, 74, 73, 67, 70, 72, 69, 78, 73, 76, 69</p> <p>To compare the data sets, Jason creates a two dot plots on the same scale. The shortest player is 65 inches and the tallest players are 84 inches.</p>	<p>Sports Social studies</p>

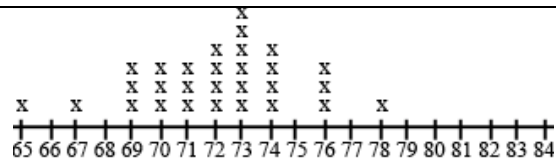

Height of Soccer Players (in)

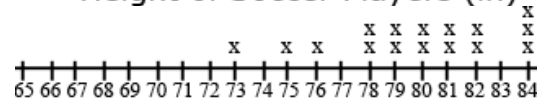

Height of Basketball Players (in)

In looking at the distribution of the data, Jason observes that there is some overlap between the two data sets. Some players on both teams have players between 73 and 78 inches tall. Jason decides to use the mean and mean absolute deviation to compare the data sets. Jason sets up a table for each data set to help him with the calculations.

The mean height of the basketball players is 79.75 inches as compared to the mean height of the soccer players at 72.07 inches, a difference of 7.68 inches.

The mean absolute deviation (MAD) is calculated by taking the mean of the absolute deviations for each data point. The difference between each data point and the mean is recorded in the second column of the table. Jason used rounded values (80 inches for the mean height of basketball players and 72 inches for the mean height of soccer players) to find the differences. The absolute deviation, absolute value of the deviation, is recorded in the third column. The absolute deviations are summed and divided by the number of data points in the set.

The mean absolute deviation is 2.53 inches for the basketball players and 2.14 for the soccer players. These values indicate moderate variation in both data sets. There is slightly more variability in the height of the soccer players. The difference between the heights of the teams is approximately 3 times the variability of the data sets ($7.68 \div 2.53 = 3.04$).

Soccer Players (n = 29)		
Height (in)	Deviation from Mean (in)	Absolute Deviation (in)
65	-7	7
67	-5	5
69	-3	3
69	-3	3
69	-3	3
70	-2	2
70	-2	2

Basketball Players (n = 16)		
Height (in)	Deviation from Mean (in)	Absolute Deviation (in)
73	-7	7
75	-5	5
76	-4	4
78	-2	2
78	-2	2
79	-1	1
79	-1	1

**Math Curriculum
Grade Seven**

Essential Question(s): How can various probability models be used to show experimental probability?			
21st Century Theme: Financial, Economic, Business, and Entrepreneurial Literacy			
21st Century Skills: Critical Thinking and Problem Solving			
Content: 7.SP			
Standards: Statistics and Probability			
C. Investigate chance processes and develop, use, and evaluate probability models.			
Vocabulary: sample space, with replacement, without replacement, outcome, compound event, probability, frequency, likely, unlikely events, theoretical probability, experimental probability, impossible, unlikely, likely, or certain			
Skills	Instructional Procedures	Explanations and Examples	Interdisciplinary Connections
<p>5. Understand that the probability of a chance event is a number between 0 and 1 that expresses the likelihood of the event occurring. Larger numbers indicate greater likelihood. A probability near 0 indicates an unlikely event, a probability around 1/2 indicates an event that is neither unlikely nor likely, and a probability near 1 indicates a likely event.</p>	<ul style="list-style-type: none"> • Review fractional value • Describe probability as impossible, unlikely, likely, or certain • Demonstrate and apply rules of probability 	<p>Probability can be expressed in terms such as impossible, unlikely, likely, or certain or as a number between 0 and 1 as illustrated on the number line. Students can use simulations such as Marble Mania on AAAS or the Random Drawing Tool on NCTM's Illuminations to generate data and examine patterns.</p> <p>Marble Mania http://www.sciencenetlinks.com/interactives/marble/marblemania.html Random Drawing Tool - http://illuminations.nctm.org/activitydetail.aspx?id=67</p> <p style="text-align: center;"> 0 $\frac{1}{2}$ 1 impossible unlikely equally likely likely certain </p>	<p>Science Social Studies Language Arts</p>

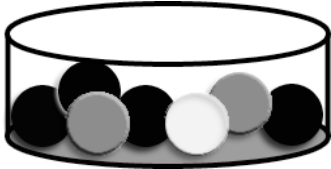
		<p>Example:</p> <ul style="list-style-type: none"> The container below contains 2 gray, 1 white, and 4 black marbles. Without looking, if you choose a marble from the container, will the probability be closer to 0 or to 1 that you will select a white marble? A gray marble? A black marble? Justify each of your predictions. 	
<p>6. Approximate the probability of a chance event by collecting data on the chance process that produces it and observing its long-run relative frequency, and predict the approximate relative frequency given the probability. <i>For example, when rolling a number cube 600 times, predict that a 3 or 6 would be rolled roughly 200 times, but probably not exactly 200 times</i></p>	<ul style="list-style-type: none"> Review probability Use probability to make predictions 	<p>Students can collect data using physical objects or graphing calculator or web-based simulations. Students can perform experiments multiple times, pool data with other groups, or increase the number of trials in a simulation to look at the long-run relative frequencies.</p> <p>Example: Each group receives a bag that contains 4 green marbles, 6 red marbles, and 10 blue marbles. Each group performs 50 pulls, recording the color of marble drawn and replacing the marble into the bag before the next draw. Students compile their data as a group and then as a class. They summarize their data as experimental probabilities and make conjectures about theoretical probabilities (How many green draws would you expect if you were to conduct 1000 pulls? 10,000 pulls?).</p> <p>Students create another scenario with a different ratio of marbles in the bag and make a conjecture about the outcome of 50 marble pulls with replacement. (An example would be 3 green marbles, 6 blue marbles, 3 blue marbles.)</p> <p>Students try the experiment and compare their predictions to the experimental outcomes to continue to explore and refine conjectures about theoretical probability.</p>	<p>Science Social Studies</p>
<p>7. Develop a probability model and use it to find probabilities of events. Compare probabilities from a model to observed frequencies; if the agreement is not good, explain possible sources of</p>	<ul style="list-style-type: none"> Define theoretical and experimental probabilities Demonstrate probability using several models Emphasize equal probabilities must have equal possible outcomes 	<p>Students need multiple opportunities to perform probability experiments and compare these results to theoretical probabilities. Critical components of the experiment process are making predictions about the outcomes by applying the principles of theoretical probability, comparing the predictions to the outcomes of the experiments, and replicating the experiment to compare results. Experiments can be replicated by the same group or by compiling class data. Experiments can be conducted using various random generation devices including, but not limited to, bag pulls, spinners, number cubes, coin toss, and colored chips. Students can collect data using physical objects or graphing calculator or web-based</p>	<p>Science Social Studies</p>

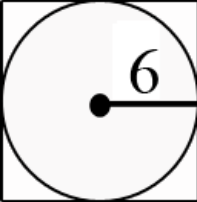
<p>the discrepancy.</p> <p>CCSS.Math.Content.7.SP.C.7a Develop a uniform probability model by assigning equal probability to all outcomes, and use the model to determine probabilities of events. <i>For example, if a student is selected at random from a class, find the probability that Jane will be selected and the probability that a girl will be selected.</i></p> <p>CCSS.Math.Content.7.SP.C.7b Develop a probability model (which may not be uniform) by observing frequencies in data generated from a chance process. <i>For example, find the approximate probability that a spinning penny will land heads up or that a tossed paper cup will land open-end down. Do the outcomes for the spinning penny appear to be equally likely based on the observed frequencies?</i></p>		<p>simulations. Students can also develop models for geometric probability (i.e. a target).</p> <p>Example:</p> <ul style="list-style-type: none"> If you choose a point in the square, what is the probability that it is not in the circle? 	
<p>8. Find probabilities of compound events using organized lists, tables, tree diagrams, and simulation.</p> <p>CCSS.Math.Content.7.SP.C.8a Understand that, just</p>	<ul style="list-style-type: none"> Define compound events Demonstrate compound events using lists, tables, tree diagrams, and simulations (multiple forms) 	<p>Examples:</p> <ul style="list-style-type: none"> Students conduct a bag pull experiment. A bag contains 5 marbles. There is one red marble, two blue marbles and two purple marbles. Students will draw one marble without replacement and then draw another. What is the sample space for this situation? Explain how you determined the sample space and how you will use it to find the probability of drawing one blue 	

as with simple events, the probability of a compound event is the fraction of outcomes in the sample space for which the compound event occurs.

[CCSS.Math.Content.7.SP.](#)

[C.8b](#) Represent sample spaces for compound events using methods such as organized lists, tables and tree diagrams. For an event described in everyday language (e.g., “rolling double sixes”), identify the outcomes in the sample space which compose the event.

[CCSS.Math.Content.7.SP.](#)

[C.8c](#) Design and use a simulation to generate frequencies for compound events. *For example, use random digits as a simulation tool to approximate the answer to the question: If 40% of donors have type A blood, what is the probability that it will take at least 4 donors to find one with type A blood?*

- Represent sample space

marble followed by another blue marble.

- Show all possible arrangements of the letters in the word FRED using a tree diagram. If each of the letters is on a tile and drawn at random, what is the probability that you will draw the letters F-R-E-D in that order? What is the probability that your “word” will have an F as the first letter?

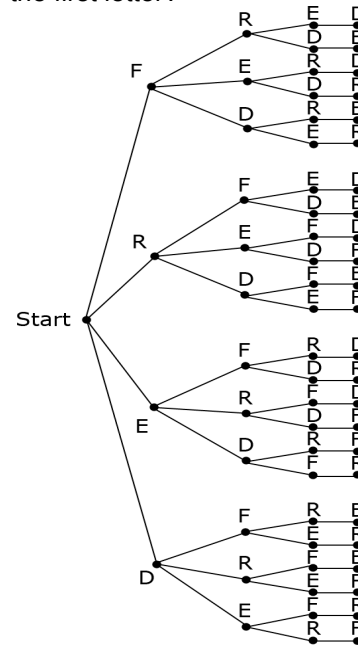

Course: Grade 7 Mathematics
Curriculum Map-Draft
Textbook: Math in Focus, Marshall Cavendish, 2013

MONTH	CHAPTER/TOPIC	ASSESSMENTS
September	Chapter 1 The Real Number System	Assessment – Chapter 1
October	Chapter 2 – Rational Number Operations	Assessment – Chapter 2
November	Chapter 3 – Algebraic Expressions	Benchmark Assessment Chap 1-2 Assessment – Chapter 3
December	Chapter 4 – Algebraic Equations and Inequalities	Assessment – Chapter 4
January	Chapter 5 – Direct and Inverse Proportion	Assessment – Chapter 5 Benchmark Assessment Chap 3-5
February	Chapter 6 – Angle Properties and Straight Lines	Assessment – Chapter 6
March	Chapter 7 – Geometric Construction	Assessment – Chapter 7
April	Chapter 8 -Volume and Surface Area of Solids	Assessment – Chapter 8 Benchmark Assessment Chap. 6-8
May	Chapter 9 - Statistics	Assessment – Chapter 9
June	Chapter 10 - Probability	Assessment – Chapter 10 End of Year Assessment